

Operating Instructions

Fronius Smart Meter TS 100A-1



EN-US | Operating instructions



Table of contents

Safety Instructions	5
Safety rules.....	7
Explanation of Safety Instructions.....	7
General.....	7
Environmental conditions.....	8
Qualified personnel.....	8
Copyright.....	8
Data backup.....	8
General information	9
Fronius Smart Meter TS 100A-1.....	11
Device description.....	11
Information on the device.....	11
Intended use.....	12
Scope of supply.....	13
Positioning.....	13
Installation	15
Installation.....	17
Checklist for installation.....	17
Installation.....	17
Protective circuit.....	17
Cabling.....	18
Fitting the protective cover for the terminals.....	19
Connecting the data communication cable to the inverter.....	19
Terminating resistors - explanation of symbols.....	20
Connecting the terminating resistor.....	20
Terminating resistors.....	21
Mounting the connection cover.....	22
Multi meter system - Explanation of symbols.....	22
Modbus participant - Fronius SnapINverter.....	23
Multi-meter system - Fronius SnapINverter.....	23
Modbus participant - Fronius GEN24.....	24
Multi meter system - Fronius GEN24 inverter.....	25
Menu - Measured variables.....	26
Configuration menu - structure and parameters.....	28
Setting the address on the Fronius Smart Meter TS.....	29
Error messages.....	30
Commissioning	31
Fronius SnapINverter.....	33
General.....	33
Connect to Fronius Datamanager 2.0.....	33
Configuring the Fronius Smart Meter TS as the primary meter.....	33
Configuring the Fronius Smart Meter TS as a secondary meter.....	34
Fronius GEN24 inverter.....	35
General.....	35
Installation using the web browser.....	35
Configuring the Fronius Smart Meter TS as the primary meter.....	36
Configuring the Fronius Smart Meter TS as a secondary meter.....	36
Technical data.....	38
Technical data.....	38
Fronius manufacturer's warranty.....	40

Safety Instructions

Safety rules

Explanation of Safety Instructions

DANGER!

Indicates an immediate danger.

- ▶ Death or serious injury may result if appropriate precautions are not taken.
-

WARNING!

Indicates a possibly dangerous situation.

- ▶ Death or serious injury may result if appropriate precautions are not taken.
-

CAUTION!

Indicates a situation where damage or injury could occur.

- ▶ Minor injury or damage to property may result if appropriate precautions are not taken.
-

NOTE!

Indicates the possibility of flawed results and damage to the equipment.

General

The device has been manufactured using state-of-the-art technology and according to recognized safety standards. If used incorrectly or misused, however, it can cause

- serious or fatal injury to the operator or a third party,
 - and damage to the device and other material assets belonging to the operating company.
-

All persons involved in start-up operation, maintenance and servicing of the device must

- be suitably qualified,
 - have knowledge of and experience in dealing with electrical installations and
 - have fully read and precisely followed these Operating Instructions.
-

The Operating Instructions must always be kept on hand wherever the device is being used. In addition to the Operating Instructions, all applicable local rules and regulations regarding accident prevention and environmental protection must also be followed.

All safety and danger notices on the device

- must be kept in a legible state
 - must not be damaged/marked
 - must not be removed
 - must not be covered, pasted, or painted over.
-

The terminals can reach high temperatures.

Only operate the device when all protection devices are fully functional. If the protection devices are not fully functional, there is a risk of

- serious or fatal injury to the operator or a third party,
 - and damage to the device and other material assets belonging to the operating company.
-

Any safety devices that are not functioning properly must be repaired by an authorized specialist before the device is switched on.

Never bypass or disable protection devices.

For the location of the safety and danger notices on the device, refer to the section headed "General" in the Operating Instructions for the device.

Any equipment malfunctions which might impair safety must be remedied immediately before the device is turned on.

Your personal safety is at stake!

Environmental conditions

Operation or storage of the device outside the stipulated area will be deemed as not in accordance with the intended purpose. The manufacturer accepts no liability for any damage resulting from improper use.

Qualified personnel

The servicing information contained in these Operating Instructions is intended only for the use of qualified service engineers. An electric shock can be fatal. Do not carry out any actions other than those described in the documentation. This also applies to qualified personnel.

All cables and leads must be secured, undamaged, insulated, and adequately dimensioned. Loose connections, scorched, damaged, or under-dimensioned cables and leads must be repaired immediately by an authorized specialist.

Maintenance and repair work must only be carried out by an authorized specialist.

It is impossible to guarantee that externally (aka, third-party) procured parts are designed and manufactured to meet the demands made on them, or that they satisfy safety requirements. Use only original spare parts (also applies to standard parts).

Do not carry out any alterations, installations, or modifications to the device without first obtaining the manufacturer's permission.

Components that are not in perfect condition must be changed immediately.

Copyright

Copyright of these operating instructions remains with the manufacturer.

Text and illustrations were accurate at the time of printing, subject to change. We are grateful for suggestions for improvement and information on any discrepancies in the operating instructions.

Data backup

With regard to data security, the user is responsible for:

- backing up any changes made to the factory settings
- saving and storing personal settings

General information

Fronius Smart Meter TS 100A-1

Device description

The Fronius Smart Meter is a bidirectional electricity meter for optimizing self-consumption and recording a household's load characteristic curve. Together with a Fronius inverter or Fronius Datamanager 2.0 and a Fronius data interface, the Fronius Smart Meter allows you to view your own power consumption. The meter measures the energy flow to the loads or to the public grid and forwards the information to the Fronius inverter or Fronius Datamanager 2.0 via the Modbus RTU/RS485 interface.

CAUTION!

Danger due to non-compliance with the safety instructions

Risk of injury and damage to the device as a result.



- ▶ Follow all safety instructions.
- ▶ Switch off the power supply before establishing the mains connection.

Information on the device

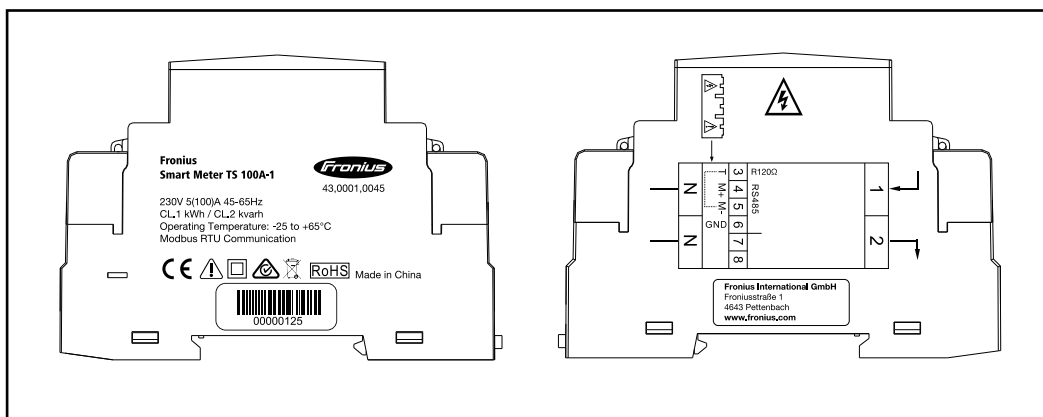
Technical data, markings, and safety symbols are located on the Fronius Smart Meter TS. These must NOT be removed or painted over. They warn against incorrect operation which can lead to serious injury and damage.



Markings:

-  The devices conform to all the requisite and relevant standards and guidelines that form part of the relevant EU directive, and are therefore permitted to display the CE mark.
-  Insulated (protection class II)
-  Regulatory Compliance Mark (RCM)
Complies with all applicable regulatory requirements in Australia and New Zealand regarding safety and electromagnetic compatibility, as well as specific requirements for radio equipment.



To comply with European Directive 2012/19/EU on Waste Electrical and Electronic Equipment and its implementation as national law, electrical equipment that has reached the end of its life must be collected separately and returned to an approved recycling facility. Any device that you no longer require must be returned to your distributor or disposed of at an approved collection and recycling facility in your area. Ignoring this European Directive may have potentially adverse effects on the environment and your health!



RoHS (Restriction of Hazardous Substances)

The limited use of certain hazardous substances in electrical and electronic equipment has been complied with in accordance with EU Directive 2011/65/EU.

Safety symbols:



Danger of serious injury and property damage due to incorrect operation.



Dangerous electrical voltage.

Intended use

The Fronius Smart Meter TS is a fixed piece of equipment for public grids of TN/TT systems and records self-consumption and/or individual loads in the system. The Fronius Smart Meter TS is required for systems with a battery storage system and/or a Fronius Ohmpilot installed for communication between the individual components. The installation is carried out on an indoor DIN rail with corresponding back-up fuses, which are adapted to the cable cross-sections of the copper conductors and to the maximum current of the meter. The Fronius Smart Meter TS must only be operated in accordance with the specifications in the enclosed documentation and in accordance with local laws, regulations, provisions, standards, and within the limits of technical possibilities. Any use of the product other than as described in the intended use shall be deemed to be not in accordance with the intended purpose. The available documentation forms part of the product and must be read, observed, and kept in good condition. It must also be accessible at all times at the place of installation. The available documents do not replace regional, state, provincial, or national laws, or regulations, or standards that apply to the installation, electrical safety, and use of the product. Fronius International GmbH assumes no responsibility for compliance with or non-compliance with these laws or regulations in connection with the installation of the product.

Interventions on the Fronius Smart Meter TS, e.g., modifications and alterations, are not permitted. Unauthorized interventions will void the warranty and warranty claims and, as a rule, void the user's authority to operate the equipment. The manufacturer shall not be liable for any damage resulting from such use.

Reasonably foreseeable misuse:

The Fronius Smart Meter TS is not suitable for supplying power to life-sustaining medical devices or for billing subtenants.

Scope of supply

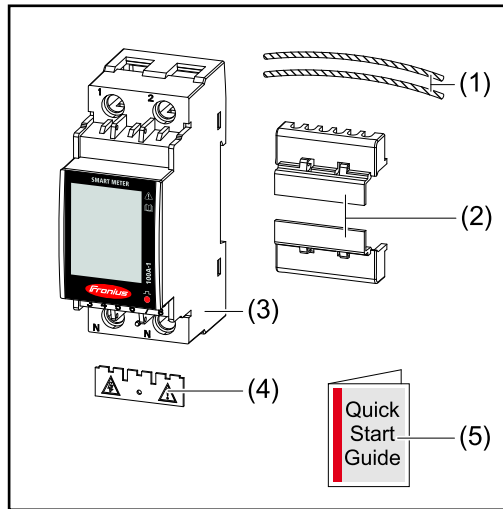

- (1) 2x seal wire
- (2) 2x connection cover
- (3) Fronius Smart Meter TS 65A-3
- (4) 1x protective cover
- (5) Quick Start Guide

Positioning

The Smart Meter can be installed in the following positions in the system:

Positioning at the feed-in point

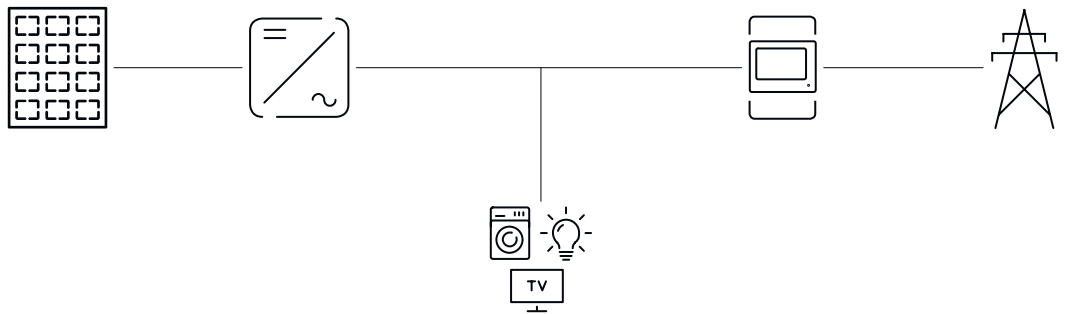

Positioning at the consumption point

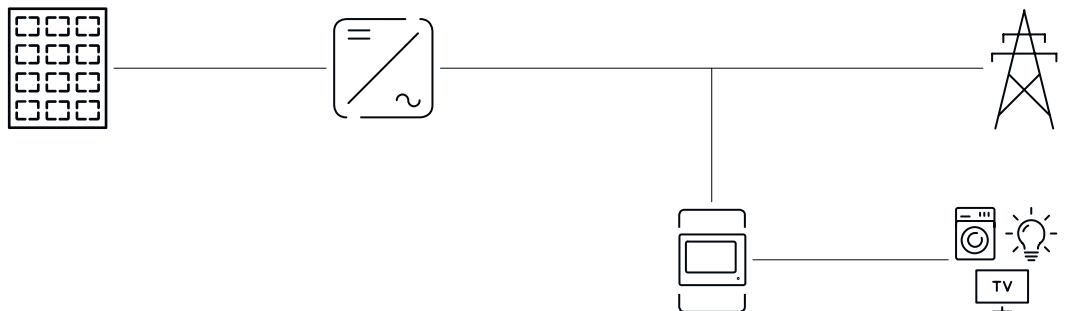

Installation

Installation

Checklist for installation

For installation information, see the following chapters:

- 1 Switch off the power supply before establishing a grid connection.
- 2 Mount the Fronius Smart Meter TS (see "[Installation](#)" on page 17).
- 3 Connect automatic circuit breakers or automatic circuit breakers and disconnectors (see "[Protective circuit](#)" on page 17).
- 4 Connect the mains cable to the Fronius Smart Meter TS (see "[Cabling](#)" on page 18).
- 5 Fit the protective cover for the terminals (see "[Fitting the protective cover for the terminals](#)" on page 19).
- 6 Connect the data communication connections of the Fronius Smart Meter TS to the Fronius system monitoring using a suitable cable (see "[Connecting the data communication cable to the inverter](#)" on page 19).
- 7 If necessary, set terminating resistors (see "[Connecting the terminating resistor](#)" on page 20).
- 8 Tug on each wire and plug to make sure that they are securely connected to the terminal blocks.
- 9 Switch on the power supply to the Fronius Smart Meter TS.
- 10 Check the firmware version of the Fronius system monitoring. To ensure compatibility between the inverter and the Fronius Smart Meter TS, the software must always be kept up to date. The update can be started via the inverter web page or using Solar.web.
- 11 If several Fronius Smart Meter TS are installed in the system, set the address (see "Setting the address" under "[Setting the address on the Fronius Smart Meter TS](#)" on page 29).
- 12 Configure and commission the meter (see [Commissioning](#) on page 31).

Installation

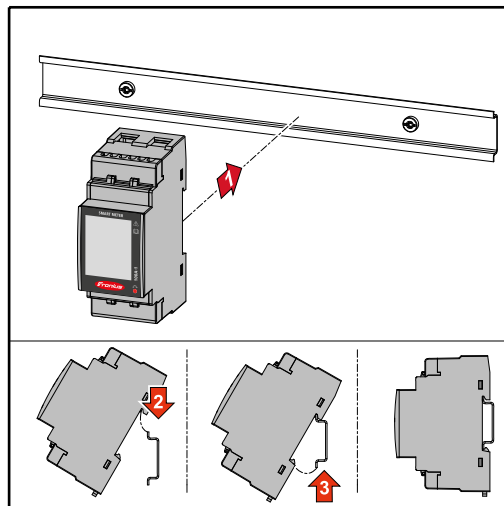

The Fronius Smart Meter TS can be mounted on a 35 mm DIN rail. The housing comprises 2 modules according to DIN 43880.

Protective circuit

The Fronius Smart Meter TS is a hard-wired device and requires a disconnecting device (circuit breaker, switch or disconnector) and overcurrent protection (automatic circuit breaker).

The Fronius Smart Meter TS consumes 10 - 30 mA, the nominal capacity of the disconnecting devices and the overcurrent protection is determined by the wire thickness, the mains voltage, and the required breaking capacity.

- Disconnecting devices must be mounted within sight and as close as possible to the Fronius Smart Meter TS; they must also be easy to use.
- The disconnecting devices must satisfy the requirements of IEC 60947-1 and IEC 60947-3, as well as all national and local regulations for electrical systems.
- Use overcurrent protection rated for max. 100 A.
- To monitor more than one mains voltage, use connected automatic circuit breakers.
- The overcurrent protection must protect the grid terminal marked L1. In rare cases, the neutral conductor has an overcurrent protection, which must interrupt both neutral and non-grounded cables concurrently.

Cabling

IMPORTANT!

Always switch off the power supply before connecting the mains voltage inputs to the Fronius Smart Meter TS.

Recommended thickness of stranded mains voltage cables for the terminals of the measuring input and measuring output:

- Wire: 1 - 25 mm²
- Recommended torque: max. 2.8 Nm

Recommended thickness of stranded wires for data communication terminals:

- Wire: min. 0.05 mm²
- Recommended torque: max. 0.5 Nm

Connect each voltage cable to the terminal strip as shown in the graphics below.

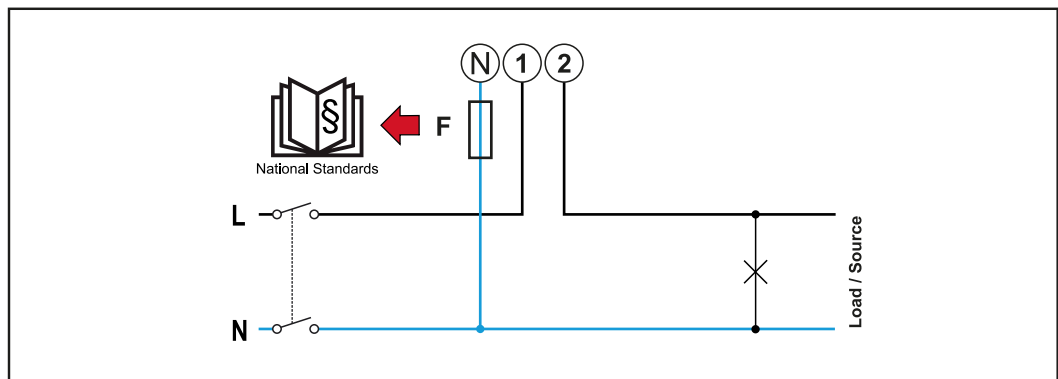

1 phase, 2 conductors

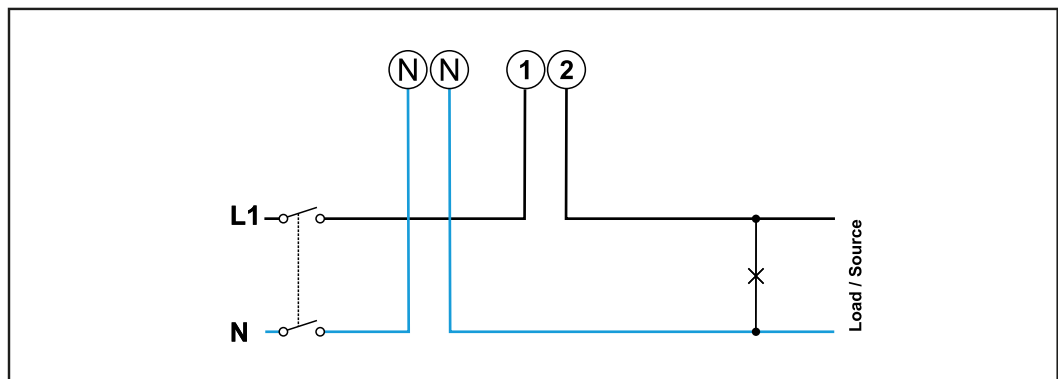

1 phase, 2 conductors

Fitting the protective cover for the terminals

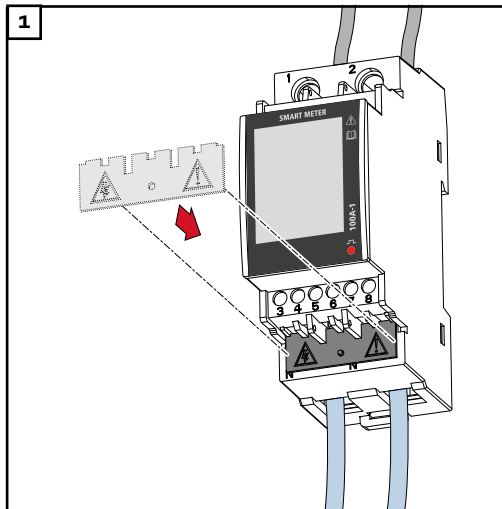

Insert the protective cover into the guide and press firmly.

⚠ WARNING!

Danger due to electrical voltage from missing or improperly fitted protective cover.

An electric shock can be fatal and/or cause serious damage to property.

- ▶ Fit the protective cover immediately after installing the live cables.
- ▶ Fit the protective cover properly and check that it is secure.

Connecting the data communication cable to the inverter

Connect the data communication connections of the Fronius Smart Meter TS to the Modbus interface of the Fronius inverter using a network cable (type CAT5 or higher).

Several Smart Meters can be installed in the system, see chapter [Multi-meter system - Fronius SnapINverter](#) on page 23.

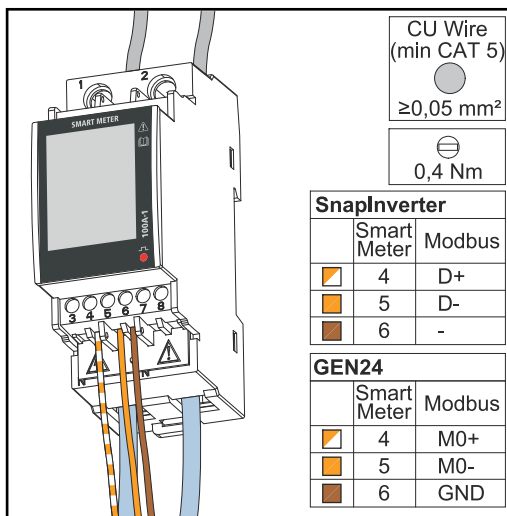

To avoid interference, the terminating resistor must be used (see chapter [Connecting the terminating resistor](#) on page 20).

IMPORTANT!

Further information for successful commissioning.

Observe the following information on connecting the data communication cable to the inverter.

- Use network cables of type CAT5 or higher.
 - The maximum cable length between the Fronius inverter and Fronius Smart Meter is 300 meters.
 - Use a mutual twisted cable pair for corresponding data lines (D+/D-, MO+/MO-).
 - On Fronius GEN24 inverters, the M0 and M1 inputs can be selected for this purpose.
 - If the data lines are close to the mains cabling, use wires or cables that are designed for 300 to 600 V (never less than the operating voltage).
 - Use double-insulated or sheathed data lines when they are close to bare conductors.
 - Use shielded twisted pair cables to avoid faults.
 - Two wires can be installed in each terminal; the wires are twisted first, inserted into the terminal, and tightened.
- Note:** A loose wire can disable an entire area of the network.
- The data communication connections of the Fronius Smart Meter TS are electrically isolated from hazardous voltages.

Terminating resistors - explanation of symbols



Inverter in the system

e.g., Fronius Symo



Meter - Fronius Smart Meter TS

Terminating resistor R 120 Ohm is set with a wire jumper between **M** and **T**.



Modbus RTU, third-party device

e.g., Fronius Ohmpilot, battery, etc.



Terminating resistor

R 120 Ohm

Connecting the terminating resistor

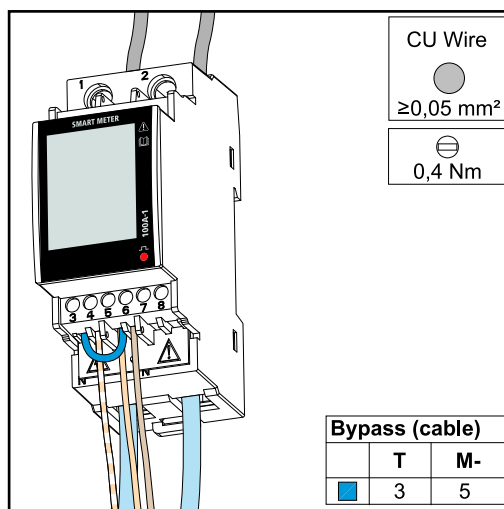

The terminating resistor is integrated in the Fronius Smart Meter TS and is manufactured with a bridge between the **M** and **T** connections (T = termination).

Terminating resistors

Due to interference, it is recommended that terminating resistors are used as illustrated below to ensure proper functioning.

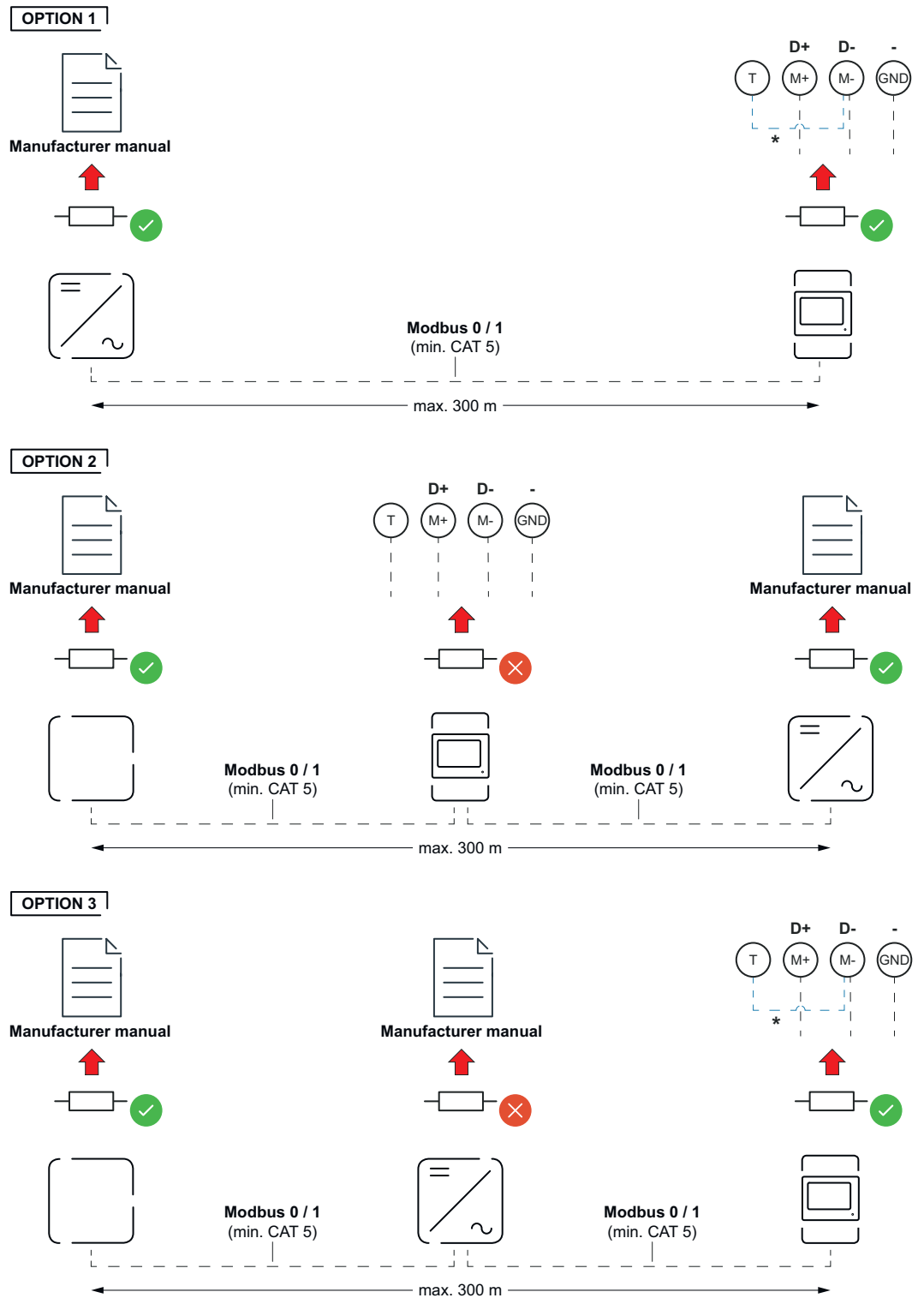

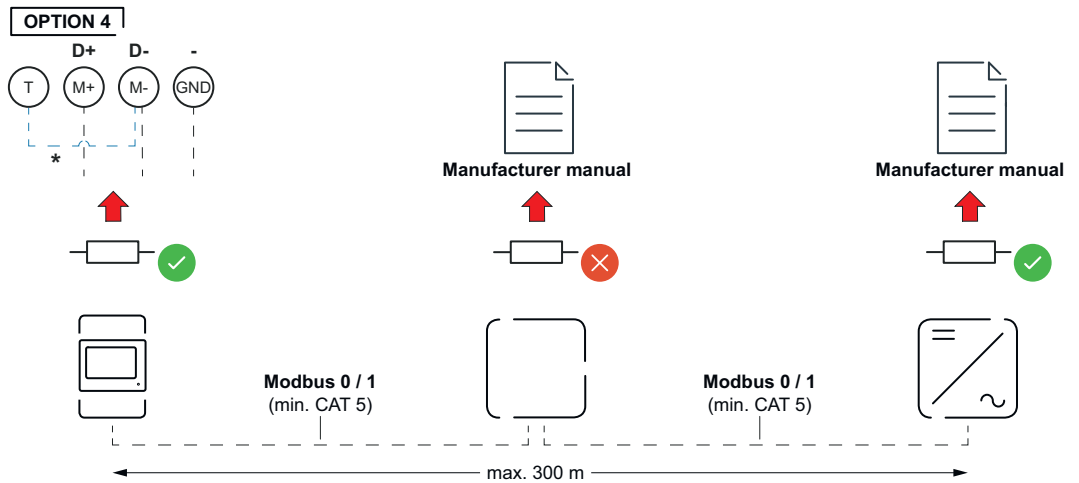

* The terminating resistor is integrated in the Fronius Smart Meter TS and is manufactured with a bridge between the **M** and **T** connections (T = termination).

Mounting the connection cover

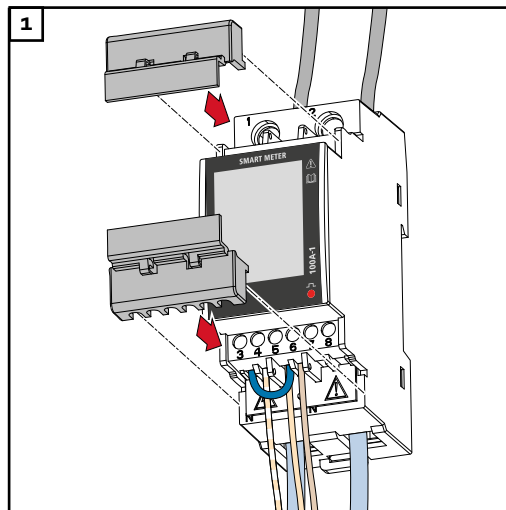

Insert the connection covers into the guides and press firmly.

IMPORTANT!

When fitting the connection covers, ensure that the cables are not kinked, pinched, crushed, or otherwise damaged.

Multi meter system - Explanation of symbols



Grid

Supplies the loads in the system if insufficient power is being generated by the PV modules or supplied by the battery.



Inverter in the system

e.g. Fronius Primo, Fronius Symo, etc.



Utility meter

Measures the metering data relevant for the billing of electricity quantities (primarily the kilowatt hours of grid purchases and grid power feed). On the basis of the data relevant for billing, the electricity retailer invoices a grid purchase and the purchaser of the surplus pays for the grid power feed.



Primary meter

Records the load curve of the system and makes the measured data available for energy profiling in Fronius Solar.web. The primary meter also regulates the dynamic feed-in control.

**Secondary meter**

Records the load curve of individual loads and producers (e.g. washing machine, lights, television, heat pump, etc.) in the consumption branch and makes the measured data available for energy profiling in Fronius Solar.web.

**Modbus RTU, Third-party device**

e.g. Fronius Ohmpilot, battery, etc.

**Loads in the system**

e.g. washing machine, lamps, TV, etc.

**Additional loads in the system**

e.g. heat pump

**Additional producers in the system**

e.g. wind power plant

**Terminating resistor**

R 120 Ohm

Modbus participant - Fronius SnapINverter

A maximum of 4 Modbus stations can be connected to the Modbus connection terminal.

IMPORTANT!

Only one primary meter, one battery and one Ohmpilot can be connected per inverter. Due to the high data transfer of the battery, the battery occupies 2 subscribers.

Example:

Input	Battery	Fronius Ohmpilot	Number of primary meters	Number of secondary meters
Modbus	✓	✓	1	0
	✓	✗	1	1
	✗	✓	1	2
	✗	✗	1	3

Multi-meter system - Fronius SnapINverter

If several Fronius Smart Meter TS are installed, a separate address must be set for each (see [Setting the address on the Fronius Smart Meter TS](#) on page 29). The primary meter is always assigned address 1. All the other meters are numbered consecutively with the address range from 2 to 14. Different Fronius Smart Meter power categories can be used in combination.

IMPORTANT!

Max. Use 3 secondary meters in the system. To avoid interference, it is recom-

mended to install the terminating resistors according to chapter **Connecting the terminating resistor** on page 20.

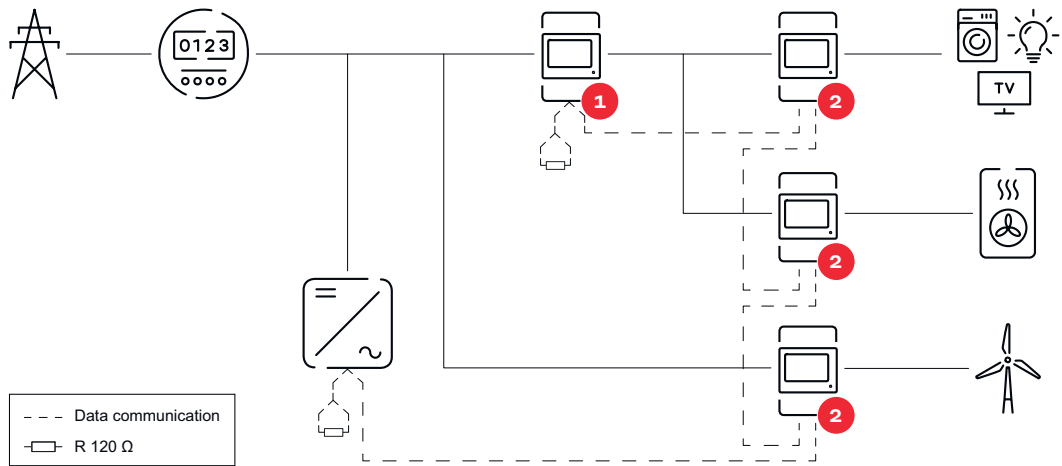

Location of the primary meter in the consumption branch. *Terminating resistor R 120 Ohm

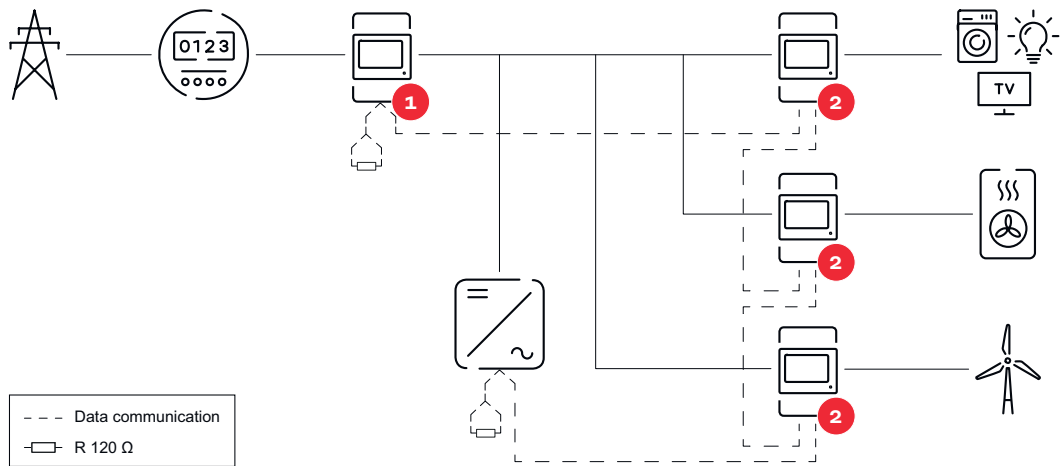

Location of the primary meter at the feed-in point. *Terminating resistor R 120 Ohm

The following must be observed in a multi-meter system:

- Only assign each Modbus address once.
- Terminating resistors must be positioned individually for each channel.

Modbus participant - Fronius GEN24

The inputs M0 and M1 can be freely selected. A maximum of 4 Modbus participants can be connected to the Modbus terminal on the inputs M0 and M1.

IMPORTANT!

Only one primary meter, one battery and one Ohmpilot can be connected per inverter. Due to the high data transfer of the battery, the battery occupies 2 subscribers.

Example 1:

Input	Battery	Fronius Ohmpilot	Number of primary meters	Number of secondary meters
Modbus 0 (M0)	✗	✗	0	4
	✓	✗	0	2
	✓	✓	0	1
Modbus 1 (M1)	✗	✗	1	3

Example 2:

Input	Battery	Fronius Ohmpilot	Number of primary meters	Number of secondary meters
Modbus 0 (M0)	✗	✗	1	3
Modbus 1 (M1)	✗	✗	0	4
	✓	✗	0	2
	✓	✓	0	1

Multi meter system - Fronius GEN24 inverter

If several Fronius Smart Meter TS are installed, a separate address must be set for each one (see [Setting the address on the Fronius Smart Meter TS](#) on page 29). The primary meter always receives the address 1. All other meters are numbered consecutively in the address range from 2 to 14. Different Fronius Smart Meter power categories can be used together.

IMPORTANT!

Use no more than 7 secondary meters in the system. To avoid interference, it is recommended to install the terminating resistors according to the chapter [Connecting the terminating resistor](#) on page 20.

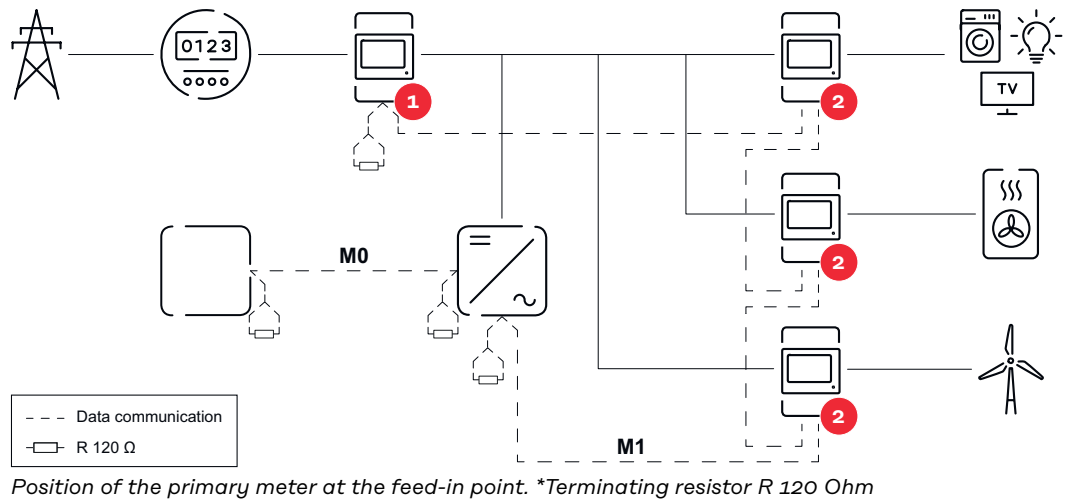
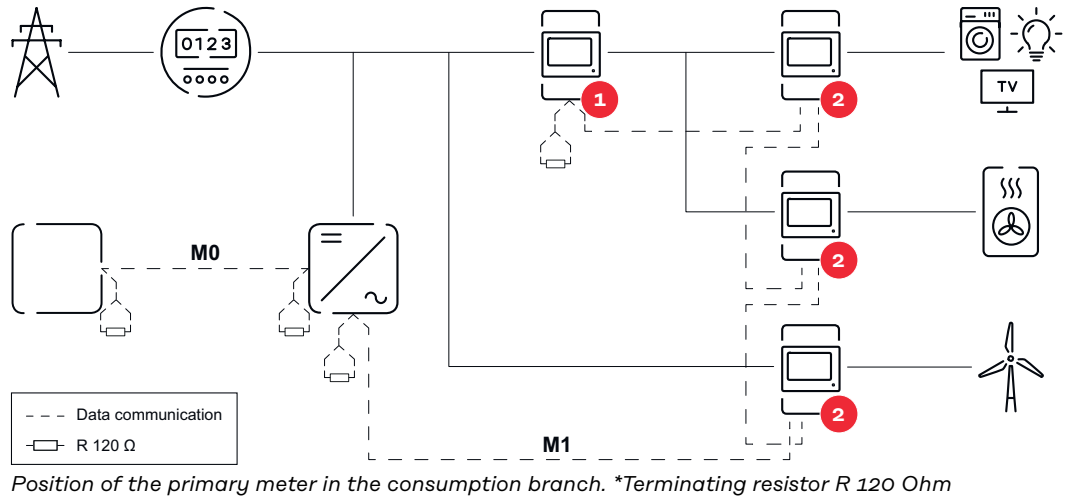

The following must be observed in a multi meter system:

- Connect the primary meter and the battery to different channels (recommended).
- Distribute the remaining Modbus participants evenly.
- Each Modbus address is assigned only once.
- Place the terminating resistors individually for each channel.

Menu - Measured variables

Image	Screen	Description
	00	<ol style="list-style-type: none"> 1. Total active energy drawn* 2. Effective power

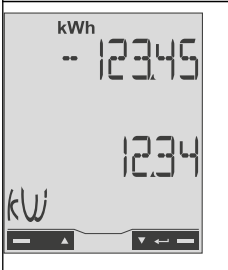
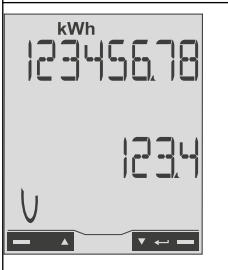

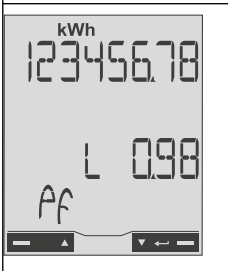
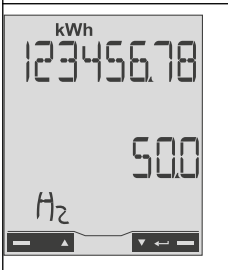





Image	Screen	Description
	01	<ol style="list-style-type: none"> Total active energy supplied** Effective power
	02	<ol style="list-style-type: none"> Total active energy drawn* Voltage
	03	<ol style="list-style-type: none"> Total active energy drawn* Current
	04	<ol style="list-style-type: none"> Total active energy drawn* Power factor (L = inductive, C = capacitive)
	05	<ol style="list-style-type: none"> Total active energy drawn* Frequency
	06	<ol style="list-style-type: none"> Total reactive energy drawn* Reactive power

Image	Screen	Description
	07	<ol style="list-style-type: none"> Total reactive energy supplied** Reactive power
	08	<ol style="list-style-type: none"> Total active energy drawn* Average demanded power (dMd = demand), calculated for the set interval. The value remains unchanged for the entire interval. It is "0" in the first interval after the start. Maximum demanded power (P = Peak demand) that has been reached since the last reset
	09	- Not used
	10	- Not used

- * Displayed when easy connection mode is activated (**measurement** = A). This value indicates the total energy without considering the direction.
- ** Factory setting - displayed when drawn and delivered energy are measured separately (**measurement** = b).

Configuration menu - structure and parameters

Screen	Code	Description	Values
PASS***	P1	Enter the current password	2633*
nPASS	P2	Password change **	Four digits (0000-9999)
MEASurE	P3	Measurement mode **	A: easy connection, measures all energy without taking the direction into account. B*: measures imported and exported energy separately.
P int	P4	Average power calculation interval (minutes)	1* - 30





Screen	Code	Description	Values
MOdE	P5	Display mode **	Full*: full display Easy: reduced display. The values that are not displayed are still transmitted via the serial interface.
tArIFF	P6	Tariff management **	On: activated Off*: deactivated
HoME	P7	Screen showing measured variables displayed at start-up and after 120 seconds of inactivity **	For full display (Mode = Full): 0 - 10*
Ad- drESS***	P10	Modbus address	1* - 247
bAUd	P11	Baud rate (kBit/s) **	9.6* / 19.2 / 38.4 / 57.6 / 115.2
PARITY	P12	Parity **	Even/No*
STOP bit	P12- 2	Only if parity = No. Stop bit. **	1* / 2
rESET	P13	Activation of the reset function for energy tariffs, maximum requested power, and part values of active and reactive energy (the latter are only transmitted via the serial interface) **	No*: reset function deactivated. Yes: reset function activated.
End	P14	Returns to the measured variables start screen	None

* Factory settings

** The settings can be protected by changing the default password (password cannot be reset).

*** Settings that need to be configured.

Setting the address on the Fronius Smart Meter TS

Symbol	Name	Event	Function
	Up	1x 	Scroll one screen forward, increase the value by 1
	Down/ Enter	1x 	Scroll one screen back, decrease the value by 1
		2 seconds 	Call up settings, confirm value



- 1 Press and hold "Down/Enter" for 2 seconds.
- 2 Press "Up" or "Down/Enter" to access the P1 screen.
- 3 Set password "2633" with "Up" and "Down/Enter" and confirm each individual value with "Down/Enter".
- 4 Note down the password.

IMPORTANT!

The password cannot be reset.

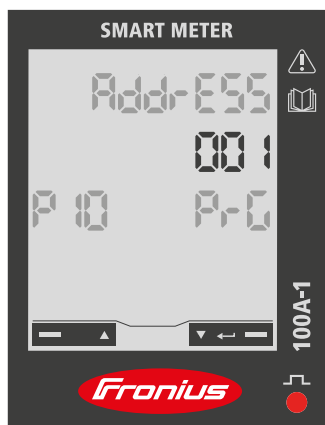

- 1 Press "Up" or "Down/Enter" to access the P10 screen.
- 2 Press and hold "Down/Enter" for 2 seconds.
- 3 Set the address with "Up" and "Down/Enter" and confirm each individual value with "Down/Enter".
- 4 Press "Up" to access the P14 screen and press and hold "Enter" for 2 seconds to exit the settings.

Error messages

If the measured signal exceeds the permissible limit values of the meter, a corresponding message appears on the display:

- EEE flashes: the measured signal value is outside the limit values.
- EEE on: the measurement depends on a value that is outside the limit values.

Note: Active and reactive energy measurements are displayed but do not change.

Commissioning

Fronius SnapINverter

General

IMPORTANT! Settings under the "Meter" menu item are only to be made by trained and qualified personnel!

The service password must be entered in order to access the "Meter" menu item.

Three-phase or single-phase Fronius Smart Meter TS can be used. In both cases, the selection is made under the "Fronius Smart Meter" item. The Fronius Datamanager automatically identifies the meter type.

A primary meter and several secondary meters can be selected. The primary meter needs to be configured first before a secondary meter can be selected.

Connect to Fronius Datamanager 2.0

Access Point:

Activate the WiFi access point of the inverter:

- 1 Select the **Setup** menu on the inverter display.
- 2 Navigate to **WiFi Access Point**.
 - ✓ *Network (SS) and password (PW) are displayed.*
- 3 Activate the **WiFi Access Point** with the Enter ↵ key.

Establish the connection from the inverter's WiFi access point to the PC:

- 1 Establish the connection to the inverter in the network settings (the inverter is displayed with the name "Fronius_240.XXXXXX").
 - 2 Enter and confirm the password from the inverter display.
 - 3 In the browser's address bar, enter the IP address <http://192.168.250.181> and confirm.
- ✓ *The Fronius Datamanager 2.0 start page is displayed.*
-

LAN:

- 1 Connect the Fronius Datamanager and computer with a LAN cable.
 - 2 Place the Fronius Datamanager 2.0 IP switch in the "A" position.
 - 3 In the browser's address bar, enter the IP address <http://169.254.0.180> and confirm.
-

Configuring the Fronius Smart Meter TS as the primary meter

- 1 Go to the Fronius Datamanager website.
 - Open the web browser.
 - In the address bar of the browser, enter the IP address (IP address for WLAN: 192.168.250.181, IP address for LAN: 169.254.0.180) or the host and domain name of the Fronius Datamanager and confirm.
 - The Fronius Datamanager website will be displayed.
- 2 Click the **"Settings"** button.
- 3 Log in to the login area with the **"service"** user and the service password.
- 4 Open the **"Meter"** menu area.
- 5 Select the primary meter from the drop-down list.
- 6 Click the **"Settings"** button.

- 7 In the pop-up window, set the position of the meter (feed-in point or consumption point). For more information on the position of the Fronius Smart Meter TS, see [Positioning](#) on page 13.
- 8 Click the **"Ok"** button when the OK status is displayed. If the *Timeout* status is displayed, try again.
- 9 Click the button to save the settings.

The Fronius Smart Meter TS is configured as a primary meter.

The **"Current general view"** menu area displays the power of the PV modules, self-consumption, the energy fed into the grid, and the battery charge (if available).

Configuring the Fronius Smart Meter TS as a secondary meter

- 1 Go to the Fronius Datamanager website.
 - Open the web browser.
 - In the address bar of the browser, enter the IP address (IP address for WLAN: 192.168.250.181, IP address for LAN: 169.254.0.180) or the host and domain name of the Fronius Datamanager and confirm.
 - The Fronius Datamanager website will be displayed.
- 2 Click the **"Settings"** button.
- 3 Log in to the login area with the **"service"** user and the service password.
- 4 Open the **"Meter"** menu area.
- 5 Select the secondary meter from the drop-down list.
- 6 Click the **"Add"** button.
- 7 Enter the name of the secondary meter in the **"Name"** input field.
- 8 Enter the previously assigned address in the **"Modbus address"** input field.
- 9 Add meter description.
- 10 Click the button to save the settings.

The Fronius Smart Meter TS is configured as a secondary meter.

Fronius GEN24 inverter

General

IMPORTANT! Settings under the "**Device configuration**" menu item are only to be made by trained and qualified personnel!

The service password must be entered in order to access the "**Device configuration**" menu item.

Three-phase or single-phase Fronius Smart Meter TS can be used. In both cases, the selection is made under the "Components" menu area. The meter type is determined automatically.

A primary meter and several secondary meters can be selected. The primary meter needs to be configured first before a secondary meter can be selected.

Installation using the web browser

WLAN:

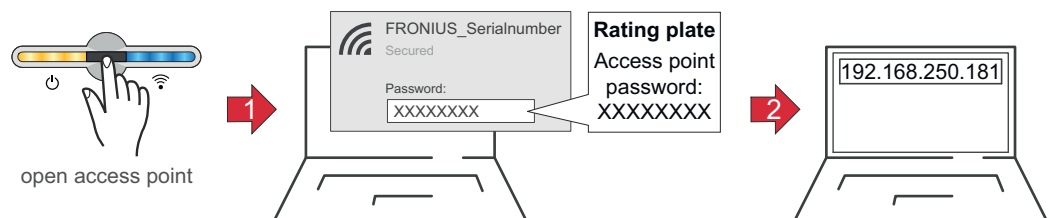

- 1 Open the access point by touching the sensor
 ✓ *Communication LED flashes blue.*
- 2 Establish the connection to the inverter in the network settings (the inverter is displayed with the name "FRONIUS_" and the serial number of the device).
- 3 Enter the password from the rating plate and confirm.
 IMPORTANT!
 To enter the password on a Windows 10 operating system, the link "**Connect using a security key instead**" must first be activated to establish a connection with the password.
- 4 In the browser address bar, enter and confirm the IP address 192.168.250.181. The installation wizard is opened.
- 5 Follow the installation wizard in the individual sections and complete the installation.
- 6 Add the system components in Fronius Solar.web and start up the PV system.

The network wizard and the product setup can be carried out independently of each other. A network connection is required for the Fronius Solar.web installation wizard.

Ethernet:

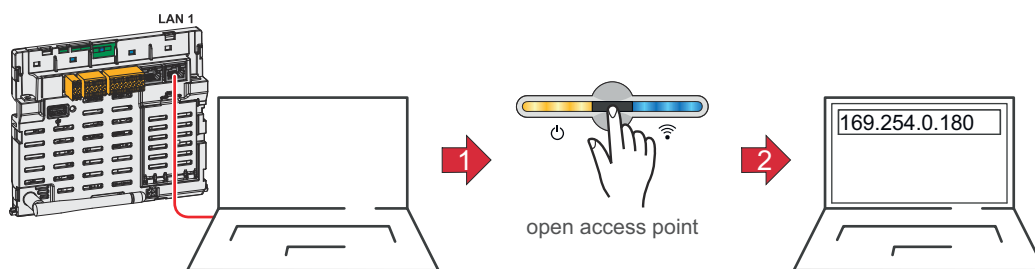

- 1 Establish a connection to the inverter (LAN1) with a network cable (CAT5 STP or higher).
- 2 Open the access point by touching the sensor once 
✓ *Communication LED flashes blue.*
- 3 In the browser address bar, enter IP address 169.254.0.180 and confirm. The installation wizard is opened.
- 4 Follow the installation wizard in the individual sections and complete the installation.
- 5 Add the system components in Fronius Solar.web and start up the PV system.

The network wizard and the product setup can be carried out independently of each other. A network connection is required for the Fronius Solar.web installation wizard.

Configuring the Fronius Smart Meter TS as the primary meter

- 1 Access the inverter website.
 - Open the web browser.
 - In the address bar of the browser, enter the IP address (IP address for WLAN: 192.168.250.181, IP address for LAN: 169.254.0.180) or the host and domain name of the inverter and confirm.
 - The inverter website is displayed.
- 2 Click the **"Device configuration"** button.
- 3 Log in to the login area with the **"Technician"** user and the technician password.
- 4 Access the **"Components"** menu area.
- 5 Click the **"Add component"** button.
- 6 In the "Position" drop-down list, set the position of the meter (feed-in point or consumption point). For more information on the position of the Fronius Smart Meter TS, see [Positioning](#) on page 13.
- 7 Click the **"Add"** button.
- 8 Click the **"Save"** button to save the settings.

The Fronius Smart Meter TS is configured as a primary meter.

Configuring the Fronius Smart Meter TS as a secondary meter

- 1 Access the inverter website.
 - Open the web browser.
 - In the address bar of the browser, enter the IP address (IP address for WLAN: 192.168.250.181, IP address for LAN: 169.254.0.180) or the host and domain name of the inverter and confirm.
 - The inverter website is displayed.
- 2 Click the **"Device configuration"** button.

- 3 Log in to the login area with the "**Technician**" user and the technician password.
- 4 Access the "**Components**" menu area.
- 5 Click the "**Add component**" button.
- 6 In the "**Position**" drop-down list, select the meter type (producer/load meter).
- 7 Enter the previously assigned address in the "**Modbus address**" input field.
- 8 Enter the name of the meter in the "**Name**" input field.
- 9 In the "Category" drop-down list, select the category (producer or load).
- 10 Click the "**Add**" button.
- 11 Click the "**Save**" button to save the settings.

The Fronius Smart Meter TS is configured as a secondary meter.

Technical data

Technical data

Modbus transmission speed: 9600 baud

Parity bit: none

Software version:

- Fronius Datamanager 2.0 (from version 3.16.1 onwards)
- Fronius Symo Hybrid (from version 1.16.1 onwards)

Measuring input	
Nominal voltage (1-phase) Operating range	230 V 161 - 276 V
Self-consumption - voltage path (max. voltage)	≤ 8 VA
Nominal frequency Tolerance	50 - 60 Hz 45 - 65 Hz
Nominal current, I_b	5 A
Maximum current, I_{max}	100 A
Starting current	40 mA
Short-time overload (EN IEC 62053-21, EN IEC 62053-23)	30 I_{max} / 0.001 s
Self-consumption - current path (max. current)	≤ 1 W
Power factor Operating range (EN IEC 62053-21, EN IEC 62053-23)	cosφ 0.5 ind - 0.8 cap,
Current total harmonic distortion	In acc. with EN 62053-21

Data output	
RS485 communication	
Electrically isolated from measuring input	
Standard	RS485 - 3 conductors
Transmission	Serial, asynchronous
Protocol	Compatible with Modbus RTU
Addresses	1 - 255
Number of bits	8
Stop bit	1
Parity bit	None - odd - even
Baud rate	9600, 19,200 bit/s
Response time	≤ 200 ms

Insulation (EN IEC 62052-11, EN IEC 62053-21)	
Installation category	III
Pollution degree	2

Insulation (EN IEC 62052-11, EN IEC 62053-21)	
Insulation voltage	4000 VAC RMS (1 min)

Electromagnetic compatibility	
Emission test	In acc. with EN IEC 62052-11, EN 50470-3
Immunity test	In acc. with EN IEC 62052-11, EN 50470-3

Operating conditions	
Reference temperature	25 °C (±5 °C)
Operating range	-25 - 65 °C
Temperature limit for storage and transport	-30 - 80 °C
Mechanical environment Electromechanical environment	M2 E2

Housing	
Housing	2 modules according to DIN 43880
Sealable housing/terminal cover	
Connection	Screw connection
Mounting	Can be snapped onto 35 mm DIN rail
Housing material	Noryl, self-extinguishing
Degree of protection (EN 60529)	IP51 housing, IP20 connections
Weight	160 grams

Communication LED signals	
red, flashing	Pulse light according to EN50470-3, EN62052-11, 1000 pulse/kWh (min. frequency 90 ms)
orange, lights up permanently	Negative total efficiency This check is only carried out if Configuration menu - structure and parameters measurement mode "B" is active. In this case, the device measures drawn and delivered energy.

Terminals	
Measuring input	
Wire	max. 25 mm ²
Recommended torque	max. 2.8 Nm

Data output	
Wire	min 0.05 mm ²
Recommended torque	max. 0.5 Nm

Fronius manufacturer's warranty

Detailed, country-specific warranty conditions are available at www.fronius.com/solar/warranty.

To obtain the full warranty period for your newly installed Fronius product, please register at www.solarweb.com.



fronius.com/en/solar-energy/installers-partners/products-solutions/monitoring-digital-tools

**MONITORING &
DIGITAL TOOLS**

Fronius International GmbH

Froniusstraße 1
4643 Pettenbach
Austria
contact@fronius.com
www.fronius.com

At www.fronius.com/contact you will find the contact details of all Fronius subsidiaries and Sales & Service Partners.